

AIDE AU MONTAGE

GONDOLE FOND GRILLE

2 PERSONNES



OUTILS NÉCESSAIRES

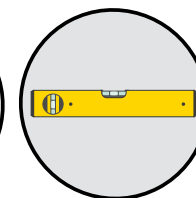
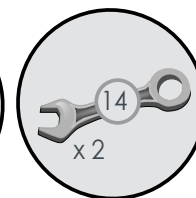
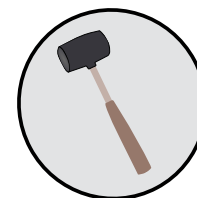

MONTAGE DES PIEDS

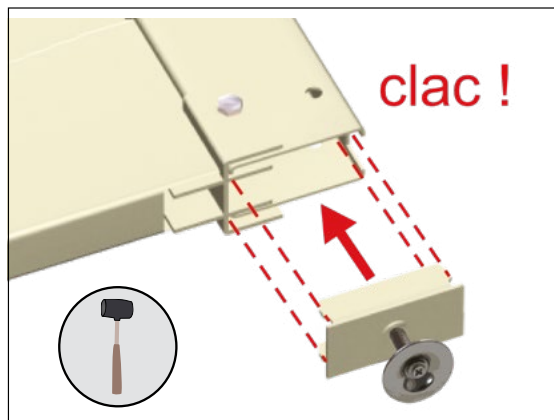
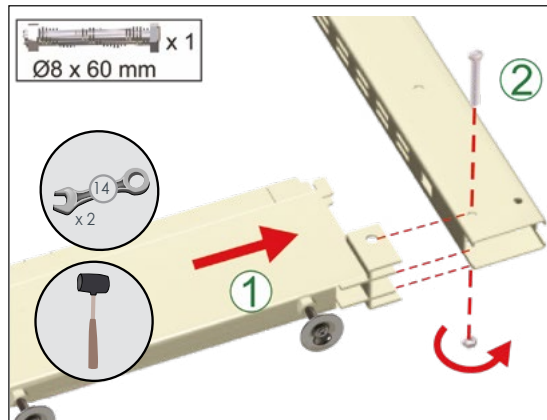

MONTAGE DE LA GONDOLE FOND GRILLE

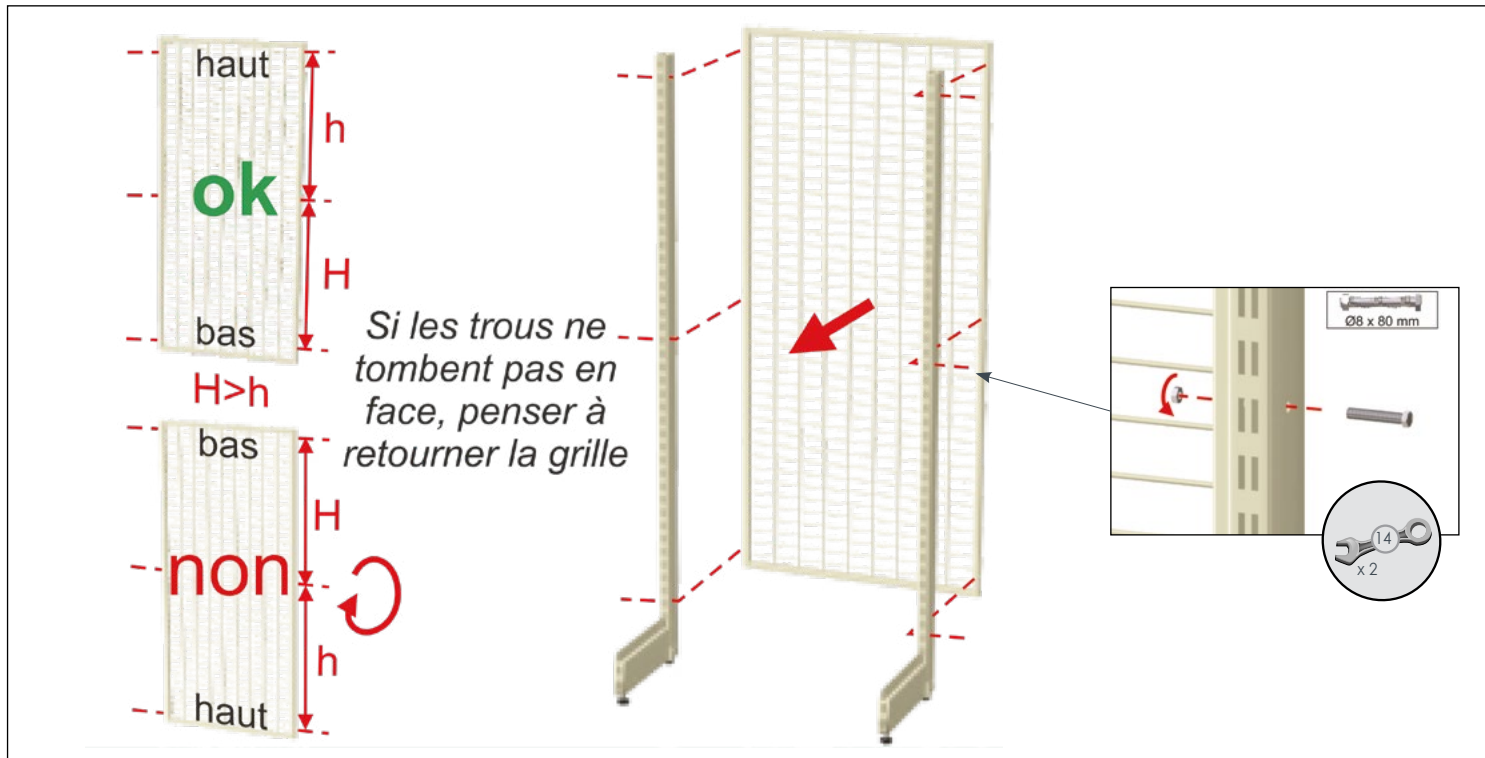

POSSIBILITÉ DE RÉHAUSSE

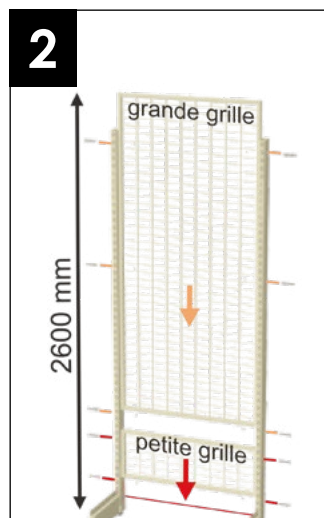
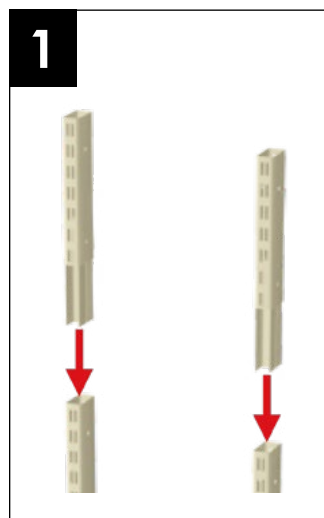

NIVEAUX DE TABLETTE

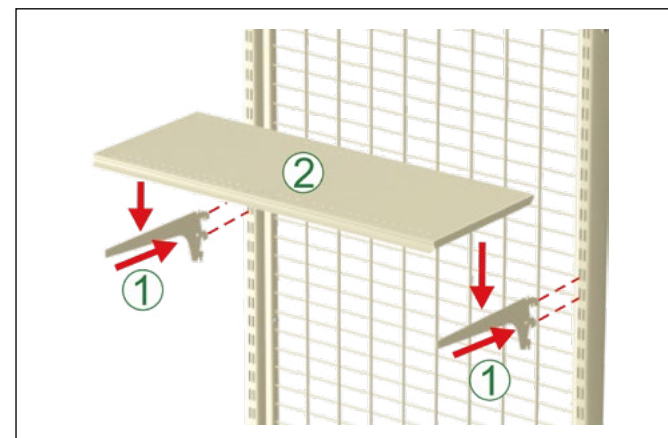

JUMELAGE DE 2 ÉLÉMENTS

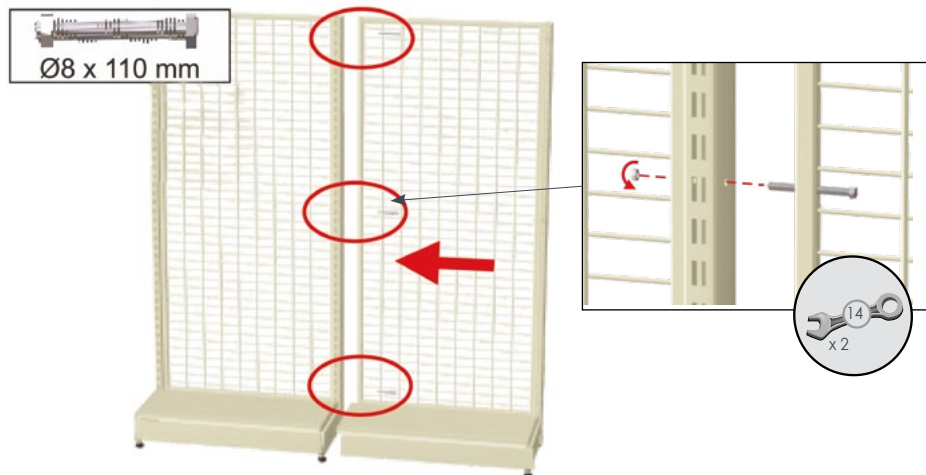

ATTENTION : 2 TYPES DE BOULONS

Boulon court
(L. 80 mm) pour
1 montant + 1 grille

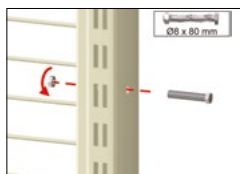

Boulon long
(L. 110 mm) pour
1 montant + 2 grilles

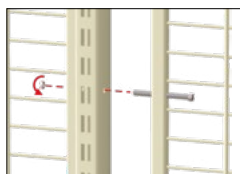

GONDOLE DOUBLE FACE

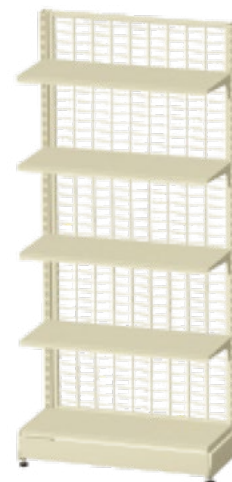

Procéder comme
précédemment pour la
pose des panneaux

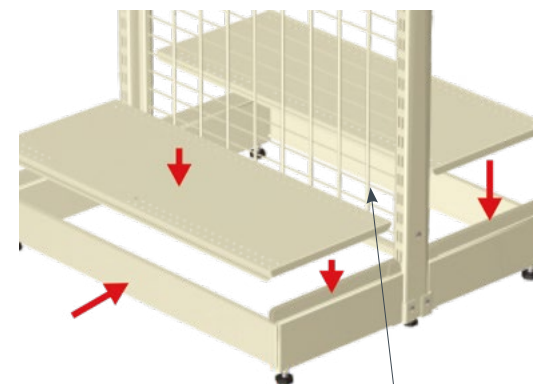

ATTENTION
1 FOND GRILLE UNIQUE CENTRAL
POUR LES DEUX FACES